

CDA/DB1

Trzpień do zawiasu
Frame pivot for hinge

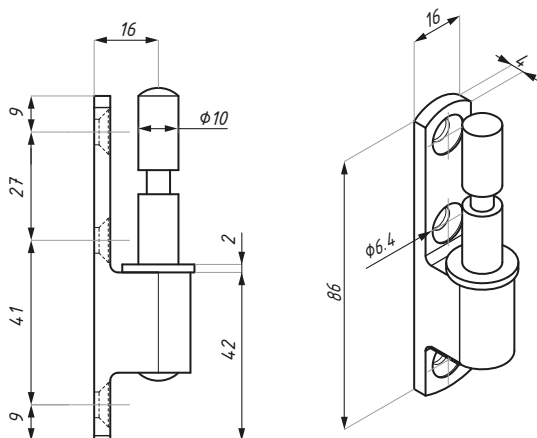

Kod / Code	Materiał / Material	Wykończenie / Finish
CDA/DB1	stal nierdzewna / stainless steel	satyna / satin
zalecana siła dokręcania śrub (Nm): M6: 15		recommended torque force for the screws (Nm): M6: 15
dla zawiasu: CDA/HR311		for hinge: CDA/HR311